

Projector Specifications

Model name	Data Projector XJ-S35	Data Projector XJ-S30
System dimensions (mm)		
Brightness	2,000 ANSI lumens	
Lamp	200W high-pressure mercury lamp	
Contrast ratio	1800:1 (telephoto mode)	
Vertical Keystone correction	Auto: +30° Manual: ±30°	
Focusing	Manual focus (electric)	
Projection lens	Optical 2X zoom (electric)	
Projection screen size	15 ~ 300 inches	
Projection range	Minimum: 0.84m 60-inch screen: 1.7m ~ 3.4m, 100-inch screen: 2.8m ~ 5.6m	
Projection system	DLP® system	
Display element	0.55-inch DLP® chip 786,432 pixels (1,024 x 768)	
Color reproduction	Full color (16.77 million colors)	
RGB input	Input terminal: RGB Mini D-Sub15 pin x 1 (YCbCr/YpPr input, shared) Display resolution: True: XGA (1,024 x 768), Compressed: Maximum SXGA (1,280 x 1,024)	
Video	Signal input: NTSC/PAL/PAL-N/PAL-M/PAL60/SECAM Input terminals: Composite: RCA pin terminal x 1, YCbCr/YpPr: Mini D-Subpin x 1 (RGB input, shared)	
USB	Interface: Type A x 1, USB (1.1) Host Connectable equipment: USB memory (commercially available)*1 Wireless (IEEE802.11b) Adaptor YW-2S YC-400 Multifunctional Camera System	
Power source	AC100~240V, 50/60Hz	
Dimension (W x H x D)*2	270 x 43 x 199mm (32mm at thinnest point) 10.6" x 1.7" x 7.8"	
Weight	1.8kg 3.97 lbs	
Security compatibility	Kensington compatible, Power ON password	
Other functions	Color mode, Digital zoom (4X), Freeze, Pointer, Direct Power ON, Eco-mode, Blank	
Main accessories	Wireless remote controller, AC cord, RGB cable, CD-ROM (Windows® XP/2000 compatible), Soft case	

*1 Operation with every type of USB memory is not guaranteed. We will disclose information concerning supported USB memory devices whose operation we have confirmed on our website. *2 Excluding protrusions

Connection terminals

VIDEO input terminal
Supports connection with a TV, video camera or other pin jack (RCA) VIDEO output terminal for projection of video materials.

RGB input terminal
Supports connection with a PC and projection of still image or video files stored in the PC.

USB terminal (XJ-S35 only)
Supports insertion of a commercially available USB memory device for presentations without a PC. Wireless connection is also possible using the USB Wireless Adaptor YW-2S (optionally available). This terminal is also employed for direct connection to the YC-400.

Options

Product	Model	XJ-S35	XJ-S30
Portable 60-inch screen	YN-6	Yes	Yes
Portable 80-inch screen	YN-8	Yes	Yes
Component video cable	YK-3	Yes	Yes
Replacement lamp	YL-33	Yes	Yes



Compact & lightweight, high-luminosity data projector <CASSIOPEIA PRO> Series

<p>High-Performance Models</p> <p>XJ-560 3000 ANSI lumens</p> <p>XJ-460 2500 ANSI lumens</p> <ul style="list-style-type: none"> Automatic vertical/horizontal Keystone correction Auto focus 2X zoom DLP® system installed 		<p>Super-Mobile Model</p> <p>XJ-360 2200 ANSI lumens</p> <ul style="list-style-type: none"> Ultra-compact size/1.8kg (230 x 55 x 171mm) Automatic vertical Keystone correction 2X zoom DLP® system installed 	
---	--	--	--

Use your CASSIOPEIA PRO projector in tandem with the YC-400 Multifunctional Camera System to create enhanced presentations.

Multifunctional Camera System YC-400
4-megapixel digital camera

When case closed

WIRELESS PRESENTATION

Expanded ease and functionality with a wireless network

Wireless communication is possible with up to four PCs simultaneously. Switching among and projecting images stored in the various PCs are easily managed. The setup is all completed without connecting any cables. And you're also spared the trouble of consolidating all your presentation materials in a single PC.

*The USB Wireless Adaptor YW-2S (optionally available) is required for wireless operation.
*Wireless connections with the XJ-S30 are possible in conjunction with the Multifunctional Presentation Kit YP-100 (optionally available).



- Cordless setup**
This capability spares you the trouble of connecting cables and facilitates speedy setup for projection. And packing up afterwards is obviously easier, too.
- Free-style presentations**
You can also conduct presentations while operating a PC beside the screen, making your presentations even more persuasive.
- Visual discussions**
You can connect the projector with up to four PCs simultaneously — an optimal configuration for discussion meetings.

North America <http://www.superslimprojector.com>
Europe <http://www.casio-projectors.com>

Easy wireless connection with up to four PCs

- Easy setup requiring only installation of a special software
- Supports simultaneous communication among up to four PCs.

USB Wireless Adaptor YW-2S (2 units per set)

For presentations without a PC and wireless connections using the XJ-S30

- Compact/lightweight, pocket-sized
- Features PC-free presentation function permitting projection of still images/video files saved in a USB memory without a PC.
- Permits wireless connection with up to four PCs when the USB Wireless Adaptor YW-2S (optionally available) is added.
- Enables USB connection with the YC-400 Multifunctional Camera System and operation without a PC.

Multifunctional Presentation Kit YP-100

Safety precautions

Please be sure to read the operator's manual carefully before using these products to ensure their safe use.

- Warning:** Do not use any power source voltage, connection cord or AC adapter other than those specified. To do so could result in fire or electric shock.
- Caution:** Do not install this product in any place where it could come into contact with water, moisture, steam, dust or oily smoke or in any high-temperature location. This may cause fire, electric shock or machine failure.
- This projector's light source is a high-voltage mercury lamp with extremely high internal pressure. Due to its characteristics, this lamp may explode with a bang or fail to ignite due to shock or overuse. The period of use before an explosion or failure may occur differs greatly, however, depending on the individual lamp and usage conditions. •Be sure to set up this equipment properly according to the instructions in the operator's manual. Failure to make connections properly or attempts to make alterations may result in accidents. CASIO cannot accept responsibility under such circumstances. •Specifications and designs are subject to change without notice. •The color tones of the products shown may differ from the actual products due to printing. •The screen images shown are superimposed graphics.
 - CASIO is a registered trademark of CASIO Computer Co., Ltd. in Japan. •CASSIOPEIA is a registered trademark of CASIO Computer Co., Ltd. •DLP, the DLP logo and the DLP medallion are trademarks of Texas Instruments. •XGA is a registered trademark of International Business Machines Corporation in the United States. •Windows is a registered trademark of Microsoft Corporation in the USA and/or other countries. •Other product names or company names in this catalogue are either trademarks or registered trademarks of their respective owners. •This catalogue is current as of July 2006.

<http://world.casio.com/>

CASIO®
CASIO COMPUTER CO., LTD.
Tokyo, Japan



SUPER SLIM M

2X WIDE ANGLE ZOOM LENS



SUPER SLIM PROJECTOR



AVAILABLE IN 2 SLIM MODELS

For More Flexible Visual Presentations

Conduct all your presentations in style.
Super Slim Projector XJ-S35/S30



**SUPER SLIM
PROJECTOR**

XJ-S35/S30

*Super-Slim package
(270 x 43 x 199mm, 1.8kg)*

2000 ANSI lumens high luminosity

DLP® system installed

True XGA support

MOBILE STYLE

Easily portable, for trouble-free presentations anytime and anywhere

We rethought every aspect of the projector and achieved the genuinely mobile size the market was waiting for. Just 32mm high (thinnest point) and weighing only 1.8kg, the XJ-S35/S30 slips neatly into a briefcase and travels lightly, within the building or wherever your travels take you.



Slim 32mm high (thinnest point) for a comfortable fit in your briefcase



Easy to carry with the YC-400 Multifunctional Camera System or other peripherals

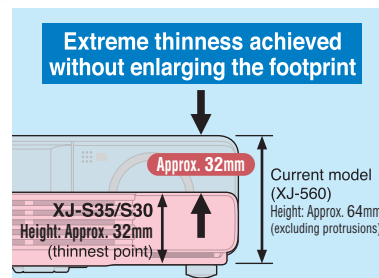

A Look at the Unique CASIO Technologies That Made This Slimness Possible

■ Lens technology

For the first time in a projector, the XJ-S35/S30 employs a lead-screw drive system for the projection lens, helping to slim down the body. We've also succeeded in downsizing the effective diameter of the lens (φ26mm) by reexamining the lens structure to improve the telecentric ratio.

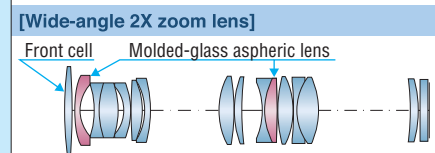
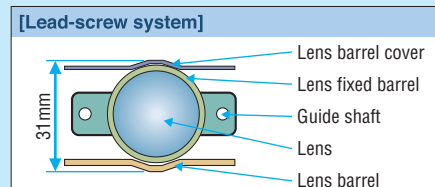

■ Light source

We developed a highly efficient, thin lamp unit due to a new-style reflector. This reflector improves the beam's luminous parallelism and contributes to drastic downsizing of the projection lens.

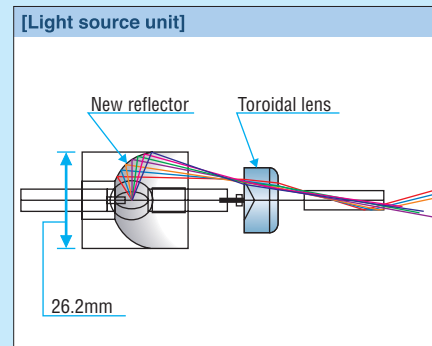

■ Cooling system

The XJ-S35/S30 is cooled efficiently by a two-chamber cooling system with a high static pressure Sirocco fan. Since heat is dispersed and radiated out by means of a heat pipe system, only a single fan is required, enabling us to make the main body thinner.

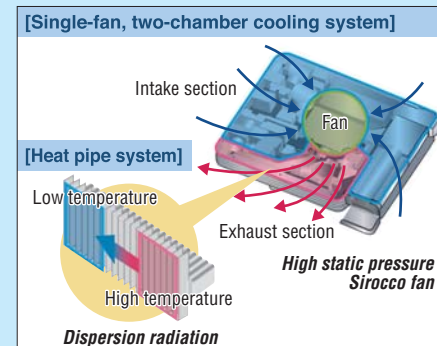

PC-FREE PRESENTATIONS

A stand-alone capability that will change your presentation style

Simply save your presentation materials in a USB memory device and project them directly from the projector itself. This not only spares you the hassle of lugging a PC around with you, but it cuts your setup time dramatically as well — so you can make maximum use of limited presentation time.

**For PC-free presentations, use the Multifunctional Presentation Kit YP-100 (optionally available) with your XJ-S30.*

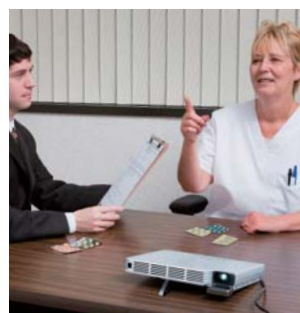

•**For enhanced sales presentations**
You don't need to bring a PC along, and you can start the presentation right away with just the projector itself.

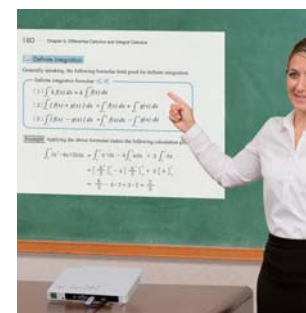

•**For daily classes**
Project educational materials from a USB memory onto the blackboard. You don't need a PC, and your before-class preparations are easier, too.

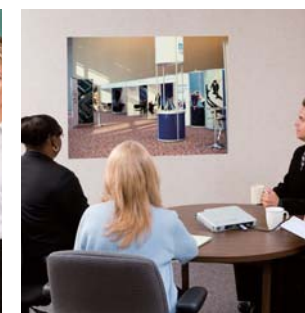

•**For sudden presentations when you're away from the office**
If you carry your XJ-S35 and a USB memory with you, you can project presentation materials on the spot whenever the opportunity arises.

2X OPTICAL ZOOM

Short-focus wide-angle lens for greater positioning freedom

The XJ-S35/S30's wide-angle 2X zoom lens achieves the highest magnification of any data projector.* It permits projection from distances as short as 84cm and supports large-screen projection in small meeting rooms — which means you can make presentations under all sorts of conditions.

**As of April 2006 (CASIO investigation result)*

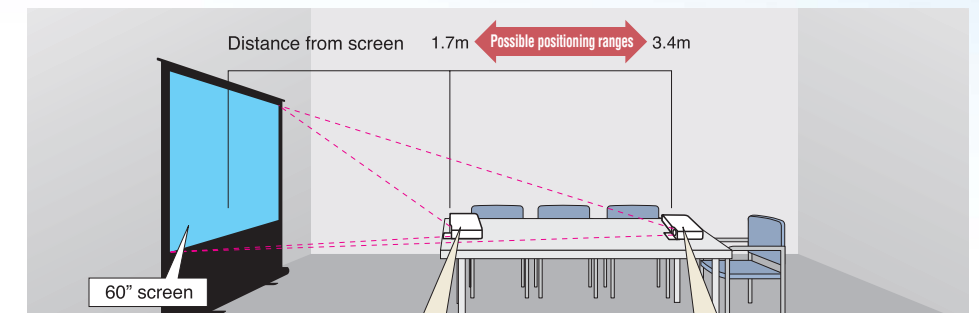

Projection ranges

Screen size	Shortest	Longest
40"	1.1m	2.2m
60"	1.7m	3.4m
80"	2.3m	4.5m
100"	2.8m	5.6m
150"	4.3m	8.5m
200"	5.7m	11.3m

**The projection ranges are rough indications for setup.*

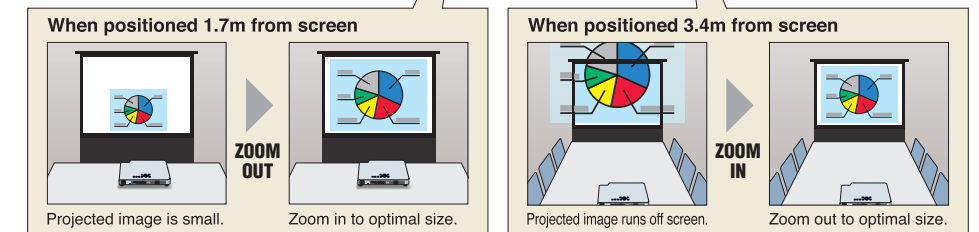

DIRECT CONNECTION

... to a **MULTIFUNCTIONAL CAMERA SYSTEM**

Lets you make presentations without a PC.*

Using your Super Slim Projector with CASIO's Multifunctional Camera System YC-400 allows easy projection of actual objects such as documents or product samples. The YC-400's 4.0 megapixel high resolution enables it to project every detail clearly.

**Using the Multifunctional Presentation Kit YP-100 (optionally available) with the XJ-S30 enables presentations without a PC.*

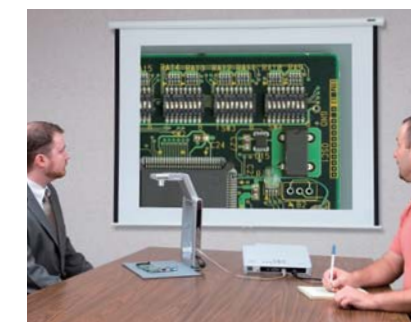

Connection with a PC adds even greater functionality.

Auto correction function

Automatically corrects projector-to-screen angle image distortions and colors. You can also enlarge only the area you want to show.

Board area function

Permits shooting/combining/replay of handwritten information on a whiteboard projection screen.

Digital camera function

Detach the camera unit and use it to take digital photos, and then project them as soon as you have reattached the camera to the stand.

Scanner mode

Conducts continuous shooting of objects placed on the document stand automatically. The image data collected can be saved quickly.

... to a **GRAPHING CALCULATOR**

Projecting a scientific calculator display onto a screen

When a graphing scientific calculator is connected to the XJ-S35/S30, the contents of the calculator display can be projected onto a screen. This ability to display calculation processes in real time is useful for lectures and practical training at universities.

**Using the Multifunctional Presentation Kit YP-100 (optionally available) with the XJ-S30 enables direct USB connection.*

